

MOTOR W/SLIDE BASE
1800 RPM, 230/460 V. 3 PH. 60 HZ

HP	FRAME	TYPE
10	215T	ODP
15	254T	TEFC
20	256T	PREMIUM EFF TEFC
25	284T	SEVERE DUTY TEFC
30	286T	XPFC
40	324T	
50	326T	

BLOWER	A	B
5009	39 3/8	4 NPT
6005	42 5/16	3 NPT
6008	42 1/4	5 NPT
7006	47 15/16	4 NPT

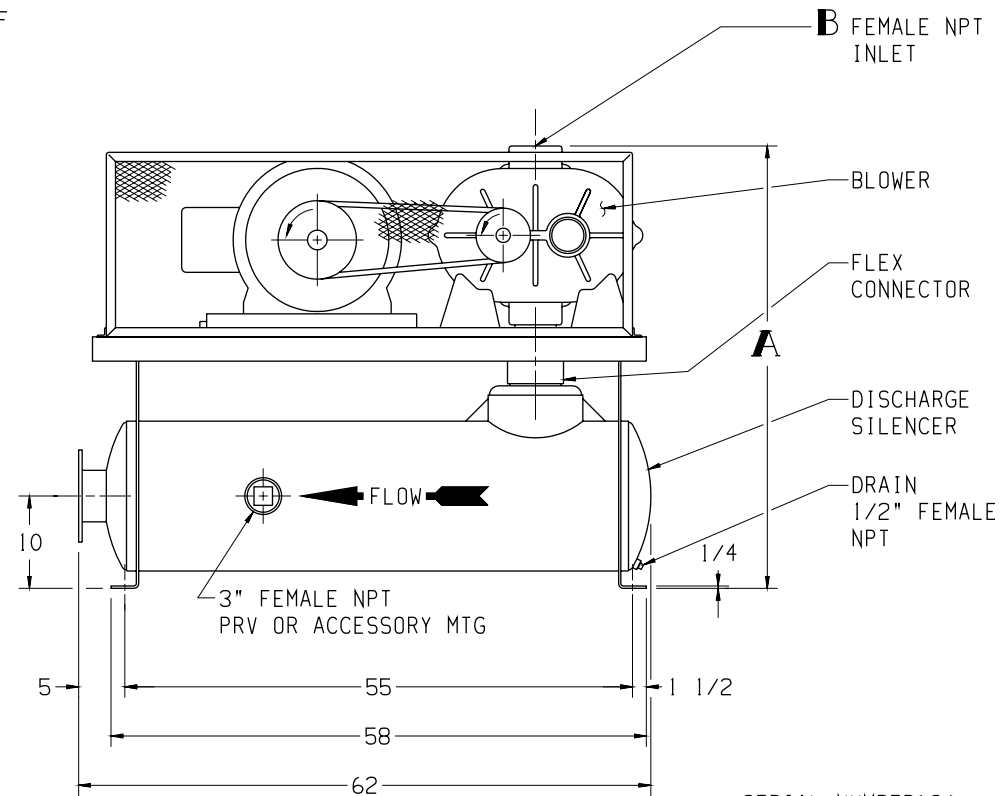
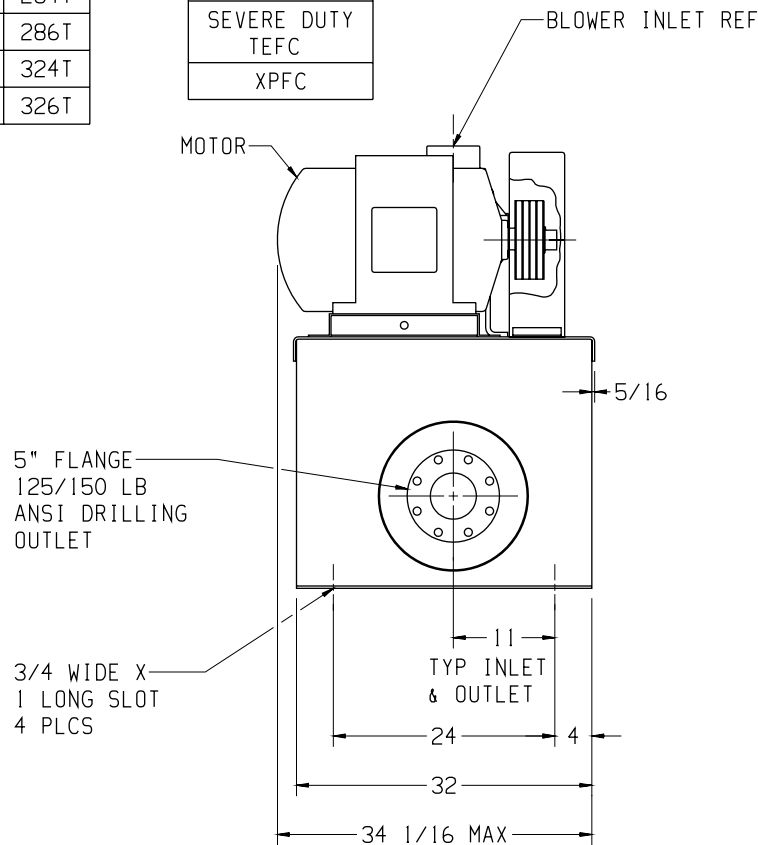

SERIAL NUMBER(S) _____
F.O. _____

APPROXIMATE WEIGHT

BASE, SILENCER, DRIVE & GUARD	530 LBS
BLOWER	___ LBS
MOTOR & SLIDE BASE	___ LBS
TOTAL WEIGHT	___ LBS

Tuthill 800.825.6937
BASE MOUNTED OUTLINE PNEU-PAK-33-50-C

SIZE: C2	
DR	BD 5-24-02
CH	_____