

MOTOR W/SLIDE BASE
1800 RPM, 230/460 V. 3 PH. 60 HZ

HP	FRAME	TYPE
7 1/2	213T	ODP
10	215T	TEFC
15	254T	PREMIUM EFF TEFC
20	256T	TEFC
25	284T	SEVERE DUTY TEFC
30	286T	TEFC
40	324T	XPFC
50	326T	

BLOWER	A
4007	68 1/4
5006	67 5/8
5009	67 5/8
6005	71 7/8
7006	75 3/4

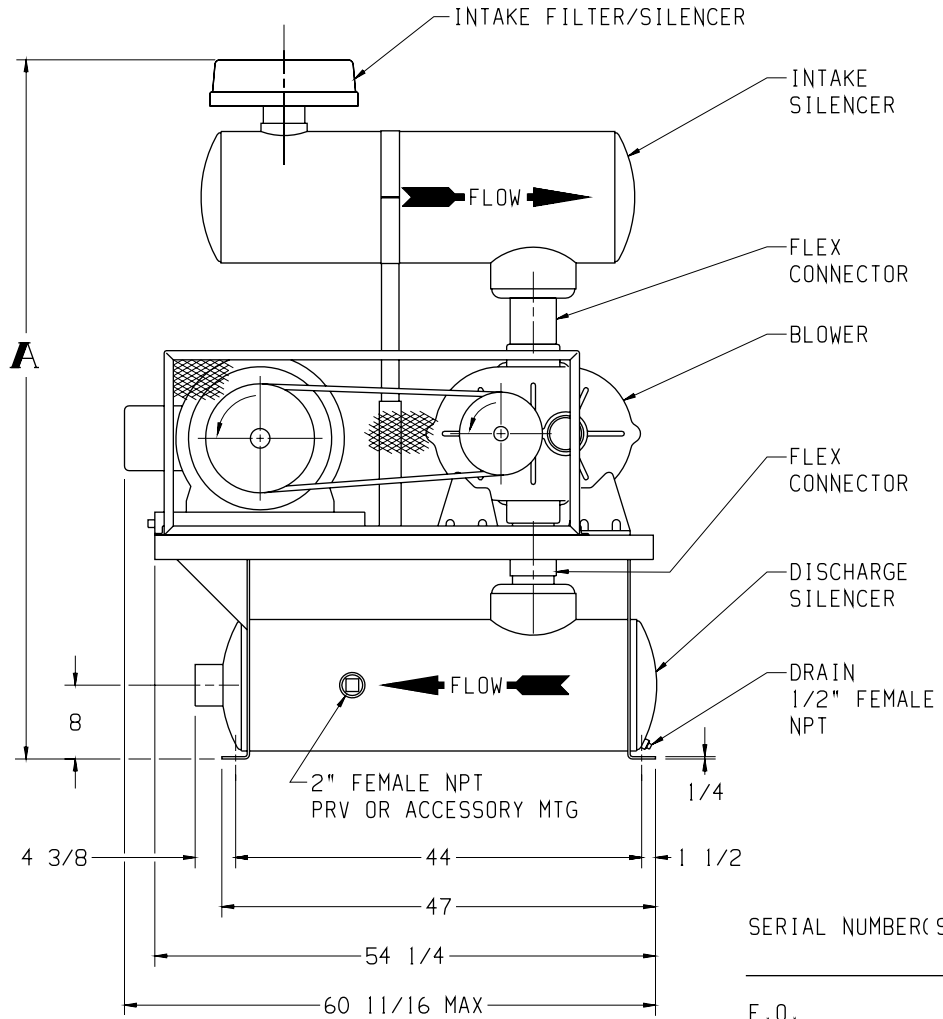
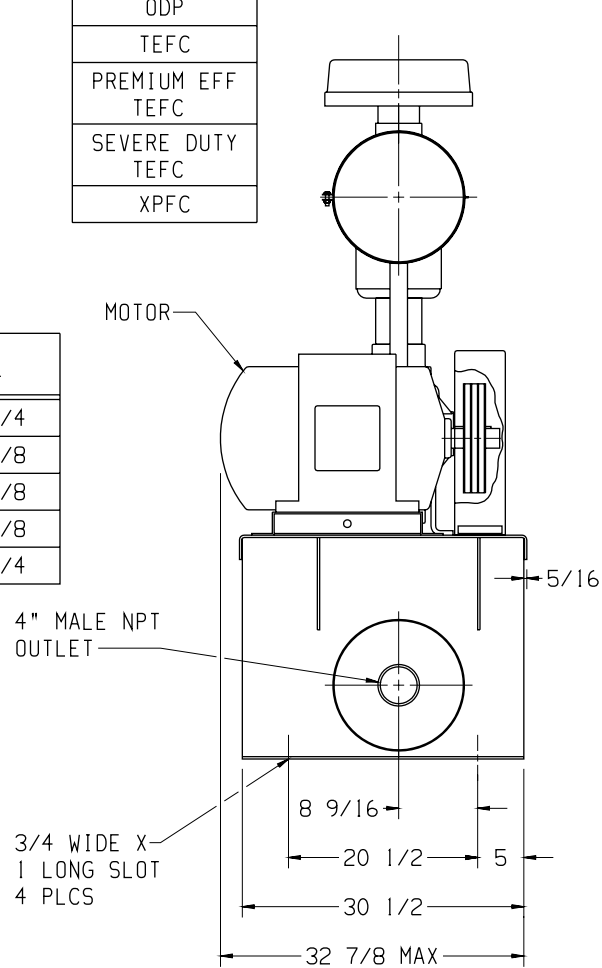

SERIAL NUMBER(S) _____
F.O. _____

APPROXIMATE WEIGHT	
BASE, SILENCERS, FILTER, DRIVE, & GUARD	475 LBS
BLOWER	___ LBS
MOTOR & SLIDE BASE	___ LBS
TOTAL WEIGHT	___ LBS

Tuthill 800.825.6937
BASE MOUNTED OUTLINE PNEU-PAK-33-40-A

SIZE: C2	
DR	BD 5-1-02
CH	_____