

MOTOR W/SLIDE BASE  
1800 RPM, 230/460 V, 3 PH, 60 HZ

HP	FRAME	TYPE
3	182T	ODP
5	184T	TEFC
7 1/2	213T	PREMIUM EFF TEFC
10	215T	SEVERE DUTY TEFC
15	254T	
20	256T	XPFC

BLOWER	A
3003	38 5/16
3006	38 7/8
4002	38 5/8
4005	38 9/16
5003	39 5/8

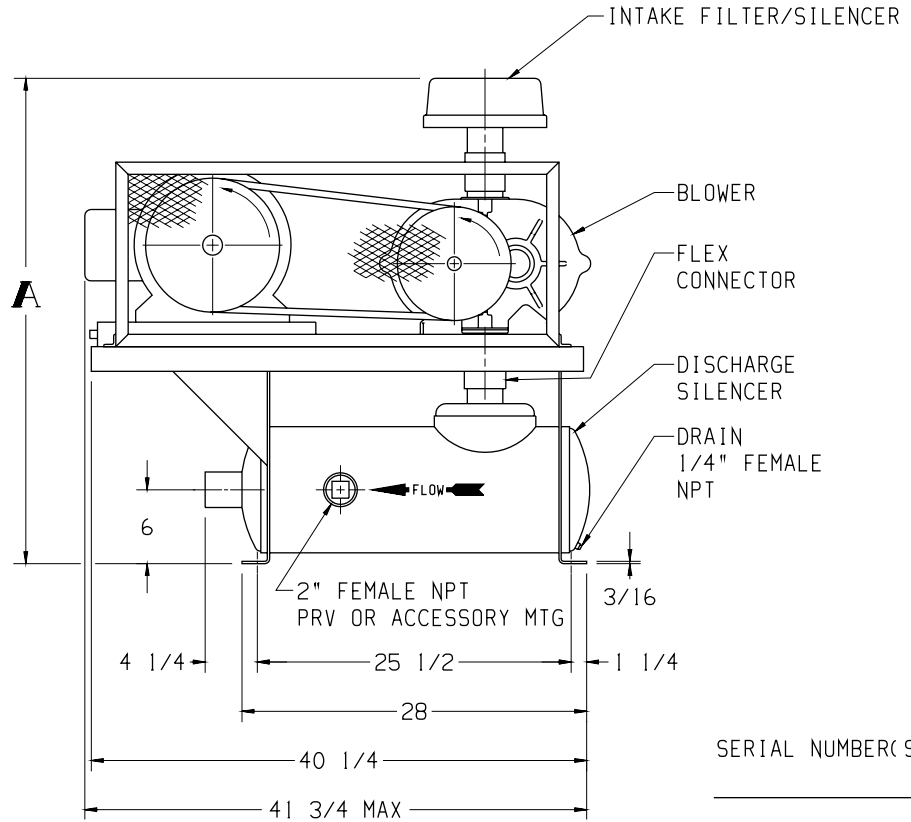
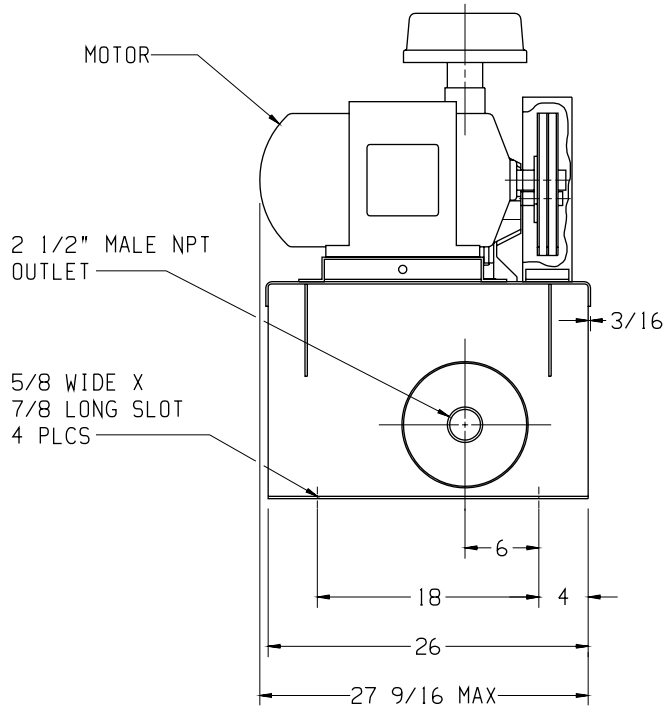

SERIAL NUMBER(S) \_\_\_\_\_  
F.O. \_\_\_\_\_

APPROXIMATE WEIGHT

BASE, SILENCER, FILTER, DRIVE, & GUARD	225 LBS
BLOWER	___ LBS
MOTOR & SLIDE BASE	___ LBS
<b>TOTAL WEIGHT</b>	<b>___ LBS</b>

**Tuthill** 800.825.6937

BASE MOUNTED OUTLINE PNEU-PAK-33-25-B

SIZE: C2

DR BD 2-11-02 CH \_\_\_\_\_