

MOTOR W/SLIDE BASE
1800 RPM, 230/460 V, 3 PH, 60 HZ

HP	FRAME	TYPE
7 1/2	213T	ODP
10	215T	TEFC
15	254T	PREMIUM EFF TEFC
20	256T	SEVERE DUTY TEFC
25	284T	XPFC
30	286T	

BLOWER	A
3006	58 11/16
4005	58 11/16
4007	58 11/16
5003	59 11/16
6005	61 3/8

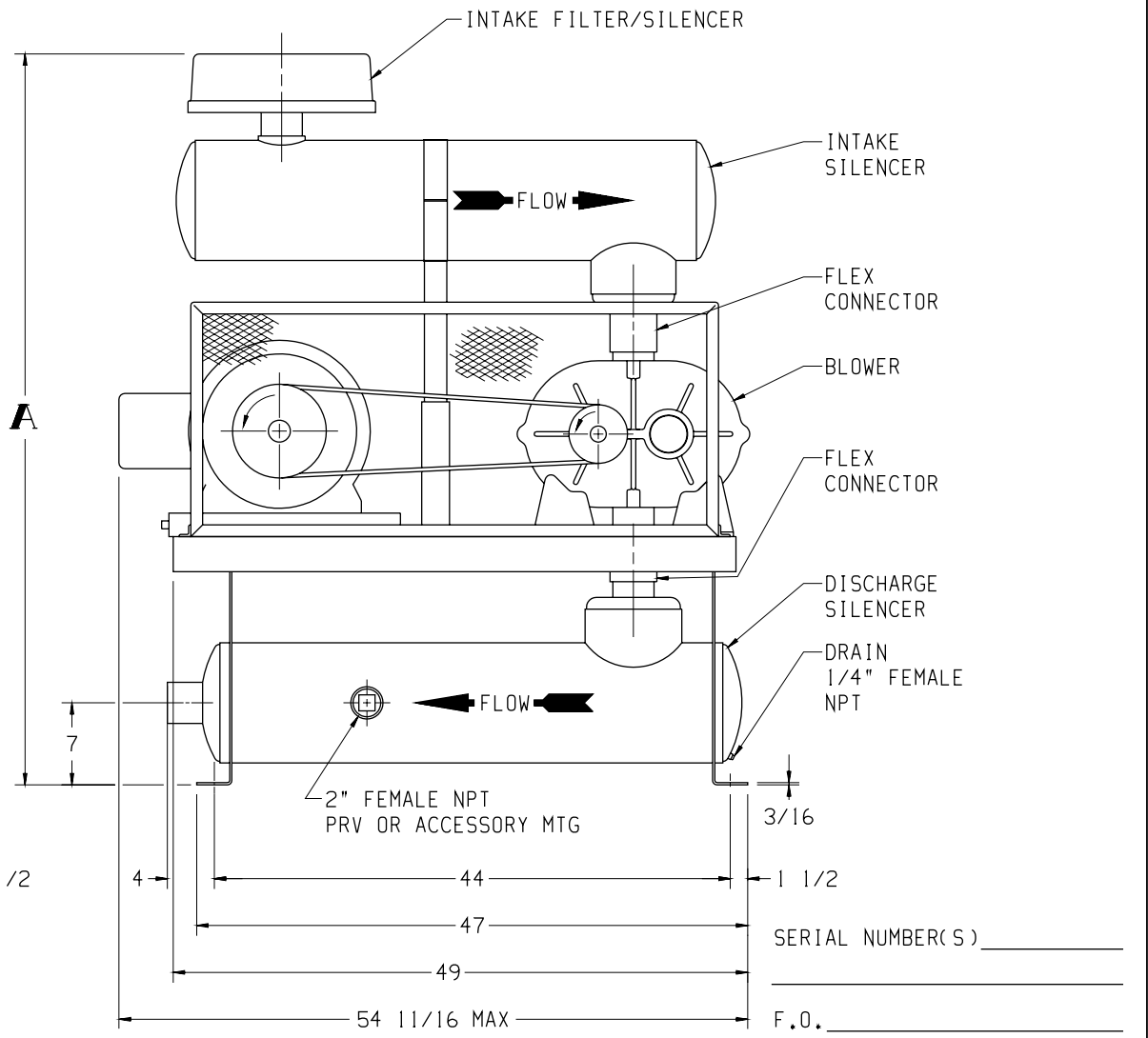
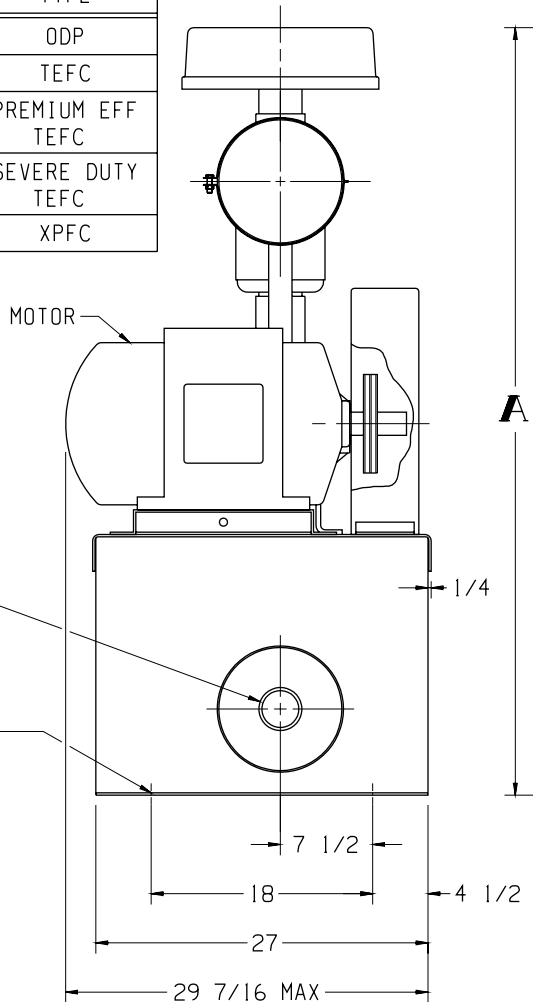

APPROXIMATE WEIGHT

BASE, SILENCERS, FILTER, DRIVE, & GUARD	397 LBS
BLOWER	___ LBS
MOTOR & SLIDE BASE	___ LBS
TOTAL WEIGHT	___ LBS

Tuthill 800.825.6937

BASE MOUNTED OUTLINE PNEU-PAK-33-30-A

SIZE:	
C2	
DR	BD 4-3-02
CH	_____